

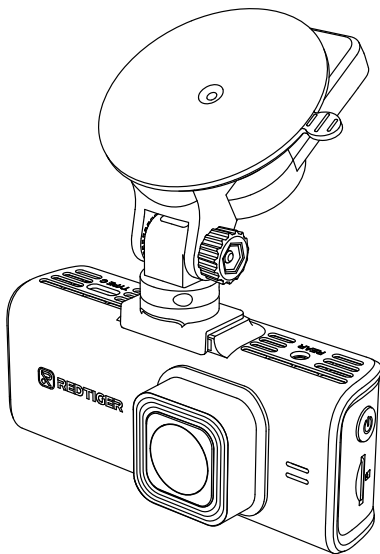

V3.1

**REDTIGER**  
CAM GOOD



# **F7N Touch** User Manual

[redtigerscam.com](http://redtigerscam.com)

The information in this manual is subject to change without notice.



# Content

Notice . . . . .	2
Product Specifications . . . . .	3
Package Contents . . . . .	4
Appearance . . . . .	5
Buttons and Functions . . . . .	6
User Interface Overview . . . . .	10
Function Overview . . . . .	13
APP and Wi-Fi Function . . . . .	16
How to Play Video on Computer . . . . .	18
Installation . . . . .	20
Trouble Shooting . . . . .	26
Customer Service Center . . . . .	28

## Notice

- Please read this manual carefully before operation and keep it for future reference. It will be helpful should you encounter any operational problem.
- Non-original parts or improper installation will void the manufacturer's warranty. The installation instructions do not apply to all types of vehicles and are written as guidelines to assist in installing the system.
- Consult an experienced technician if you are not comfortable installing the product.
- Please make sure to read and understand local laws and regulations regarding cameras and their use in a vehicle. Laws vary by state.
- Do not obscure the view of the road ahead or impede the deployment of any airbags in the event of an accident.
- When not in use, please disconnect the car adapter from both the 12/24V DC outlet in your vehicle and the device itself.
- Only clean the device with a soft dry cloth, for tough dirt, apply some neutral detergent diluted in 5 to 6 parts water on a soft cloth.
- Note that alcohol, thinner, benzene, etc could cause damage to the paint or coatings.
- Avoid making contact with the lens as this may cause damage.
- The video recordings made by this Digital Video Recorder are intended for personal use only.
- While driving, do not adjust the controls of your device as this is a distraction to driving.

## Product Specifications

Item Name	F7N Touch Dash Cam	Video Format	MP4
Screen Size	3.18" IPS Screen	Photo Format	JPG
Recording Resolution	Front 2160P @30fps / Front 1440P @60fps Front 1080P @120fps / Front 2160P+Rear1080P Front 1440P+Rear1080P		
Input	DC 5V-2.5A	Lens	Front cam F1.55 Rear camera F2.0
Operating Temperature	-4°F~158°F		
Memory Card	32GB-256GB	Warranty Period	18 Months

### Note:

In the event of a problem during use, we will offer 18 months free warranty from the date of purchase, in addition to lifetime technical support.

\*The specific warranty period is subject to local laws.

### Extended Warranty Service:

You can also get an additional 6 months of extended warranty service by registering on our website.

URL: <https://www.redtigercam.com/pages/warranty-form>

## Package Contents

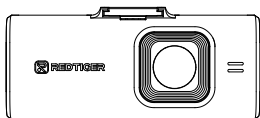

• F7N Touch 4K Dash Cam

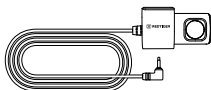

• 1080P Rear Camera

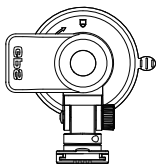

• GPS Mount

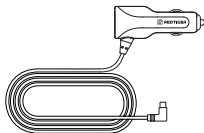

• Power Supply Cable with Car Charger

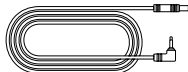

• Rear Cam Cable

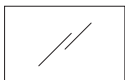

• Electrostatic Sticker\*2



• Adhesive for Suction Cup



• Adhesive



• User Manual

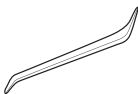

• Tool

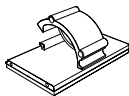

• Cable Clips\*5

## Appearance

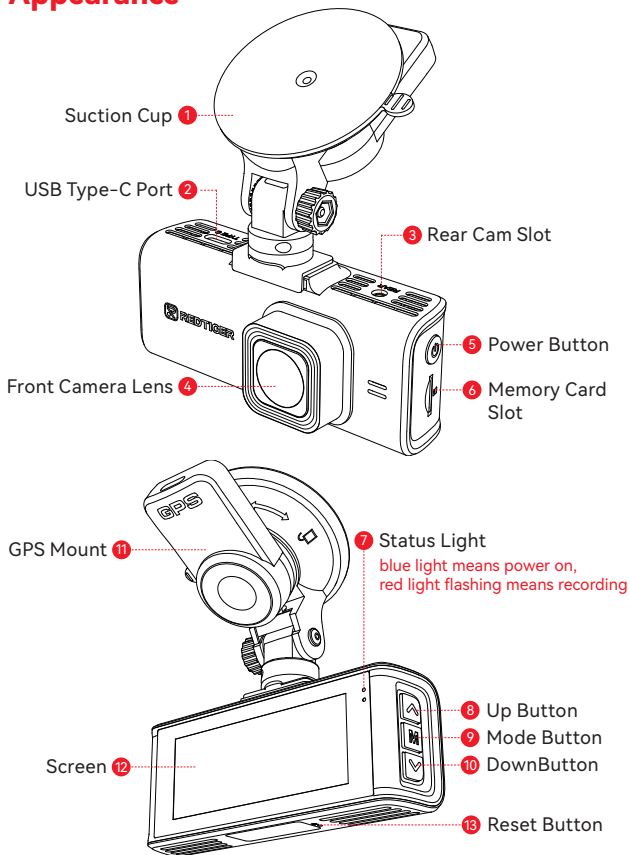

## Buttons and Functions



### Power Button

Recording Mode:

- Short press-to Switch screen
- Long press-to Turn off the Camera

Setup Mode:

- Short press-to Return to the previous screen

Playback Mode:

- Short press-to Return to the previous screen



### Menu Button

Recording Mode:

- Short press to Enter main menu

Setup Mode:

- Short press-to Enter/Confirm specific settings

Playback Mode:

- Short press-to Select and play the specific file
- Long press-to Delete/Lock/Unlock the specific file



### Up Button

Recording Mode:

- Short press-to Lock the recording file
- Long press-to Turn on or off Wi-Fi

Setup Mode:

- Short press-to Select the previous function

Playback Mode:

- Short press-to Select the previous file
- Short press-to Fast rewind while video being played



## **Down Button**

### Recording Mode:

- Short press-to Take a snapshot
- Long press-to Stop recording

### Setup Mode:

- Short press-to Select the next function

### Playback Mode:

- Short press-to Select the next file
- Short press-to Fast forward while video is being played

## • Video Mode

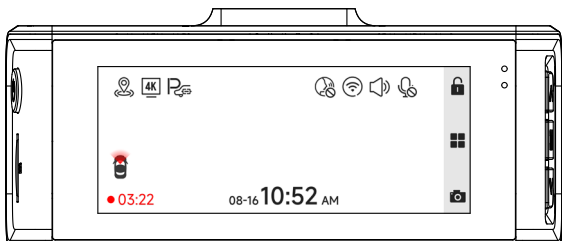

You can manually click the icon  at the top of the screen to choose whether to record audio during video recording.

You can manually click the icon  at the top of the screen to choose whether to turn on Wi-Fi.

You can manually click the icon  at the top of the screen to choose whether to turn on the key sound.

You can manually click the icon  at the top of the screen to choose whether to turn on the Voice control.

## Voice Control Function

Fast control through simple voice commands

If the icon is white , it means the function can be used normally.

You have two ways to enable this feature.

- 1 Tap on the icon to turn the feature on or off.
- 2 Enter the setting mode-voice control-on/off.

lock the video	
take picture	
turn on Audio	turn off Audio
turn on screen	turn off screen
turn on wifi	turn off wifi
turn on recording	turn off recording
show front camera	show rear camera







### Note:

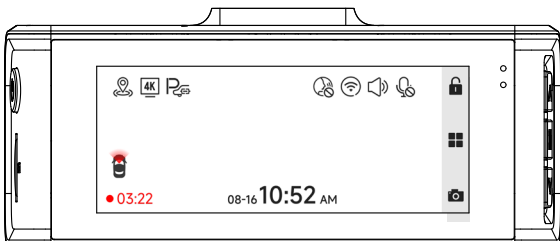



You can see the specific commands in setting-voice control.

# User Interface Overview

## • Recording Mode



Icon	Description
	GPS status
	Recording resolution
	Whether to connect the hardwired kit and set up parking monitoring
	Voice control
	Wi-Fi status
	Camera system sound status
	Voice recording status

Icon	Description
	Indicates the current video perspective displayed on the screen
● 03:22	Recording status and recording time
● 03:22	Emergency recording is on
07:20 <sub>PM</sub>	Date and time of the camera
	Emergency Video Lock
	Enter the menu
	Photograph function
●	Power Indicator
●	Red led blinking: Recording Video No Red led: Not Recording Video

## • Playback Mode

- 1 Access the Playback Folder from the Main Menu.
- 2 Press the Up or Down button to select the folder you want to play, then press the M button to enter.

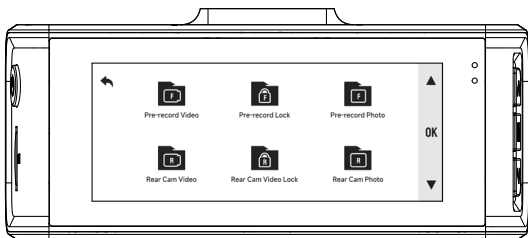

- 3 Press the M button to watch the recorded video.
- 4 Long press the M button for 3 seconds to edit your recorded videos.

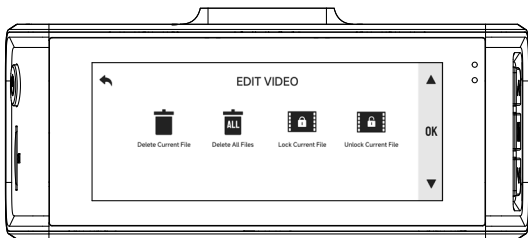























### **Note:**









All of the above functions can be done via the touch screen.

## Function Overview

Short press M button to enter settings menu, where you can adjust various functions and parameters of the entire machine.

Icon	Function	Option/Description
	Resolution	Front 2160P @30fps / Front 1440P @60fps / Front 1080P @120fps / Front 2160P+Rear1080P / Front 1440P+Rear1080P
	Audio	ON/OFF
	Recording duration	1/3/5mins
	G-sensor	Off/Low/Medium/High
	Fatigue reminder	A Reminder Will be Made During 1h/2h/3h/4h/OFF
	Wi-Fi	ON/OFF
	Click Tone	ON/OFF
	Screen Saver	OFF/10s/30s/2mins, Screen goes off after the set time
	Voice control	ON/OFF/Voice Command
	Mirror Flip	Horizontal Flip Your Rear View *Need to connect rear camera

Icon	Function	Option/Description
	Rear Cam Flip	Vertical Flip Your Rear View *Need to connect rear camera
	Parking Monitor	Please connect the ACC hardwire kit
	GPS	Display GPS signal strength
	TimeWatermark	ON/OFF
	Speed Stamp	ON/OFF
	GPS Stamp	ON/OFF
	Speed Units	KM/H / MPH
	Language	Choose Your Preferred Language
	Clock Settings	Update With GPS
	Time Format	12h/24h
	Time Zone	Choose Your Time Zone
	DST	Daylight Saving Time ON/OFF

Icon	Function	Option/Description
	Flicker	60Hz/50Hz
	Format Reminder	Reminder to Clear Data
	Format	Format SD card. All data will be deleted
	Card Speed	Card Speed Detection
	Default Setting	Reset All Settings
	APP	A QR Code for Redtiger app
	Version	Software Version
	Help Center	Scan the QR code to contact us

## Note:

- In order to a Clean, Smooth, Comfortable using experience, we suggest you format your Memory Card once a month.
- When you turn off Click Tone, the startup and shutdown sounds will also be turned off.

## APP and Wi-Fi Function

### • How to connect Wi-Fi?

#### 1. Download the APP

You can download the APP from:

- Official website: <https://www.redtigercam.com/pages/app>
- QR Code from your dash cam or on the right side.
- Apple APP Store or Google Play Store search "Redtiger".



2. Turn on the Wi-Fi on the dash cam, the Wi-Fi and SSID and password will appear on the screen.
3. Open Redtiger APP> jump to the Wi-Fi connection interface according to the steps> find the Wi-Fi of the dash cam> enter the password to connect.  
(The default password is 12345678)
4. After successfully connecting to Wi-Fi, return to the APP to use it.

### • View/Download/Delete/Share Video

1. Click the icon on the main interface to view video and picture files.
2. Long press the video file and select it, then choose to download or delete.
3. Return to the APP home page and select the Album> Open and watch/share it.

## • App home

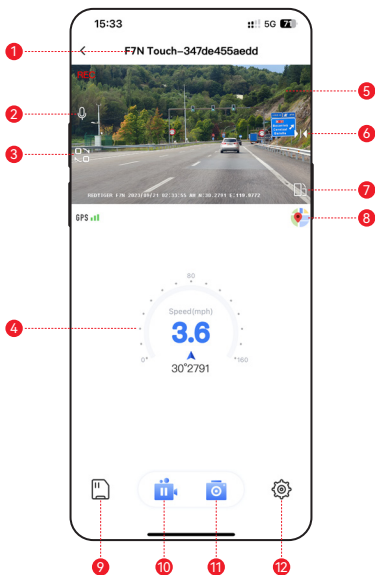

1 Native Wi-Fi Name

3 Switch recording screen

5 Video play window

7 Rotate the video screen left and right

9 Dash cam file

11 Take pictures

2 Turn on/off recorded sound

4 GPS information

6 Mirror Flip

8 Map

10 Pause/start recording

12 Dash cam settings

## • OTA(Over the air) Update

**Note:** Please update the Redtiger APP to the latest version to use this function.

1. Disconnect the mobile phone and dash cam Wi-Fi.  
Connect the phone to lan for 5 seconds, then disconnect.  
Finally, connect the dash cam Wi-Fi.
2. Once Wi-Fi connection is successful, open the Redtiger APP to start using it. If new software is detected, the APP page will indicate the availability of an update.
3. To upgrade, click on "Upgrade Now". The Redtiger APP will prompt you to download the upgrade package.  
Please note that the actual firmware should prevail over the upgrade package.
4. Connect the dash cam to send the upgrade package.  
Do not power off the dash cam during the upgrade process.  
Once the upgrade is completed, the APP will display the upgrade success message, and the dash cam will automatically restart.

## How to Play Video on Computer

We recommend using REDTIGER Player as the right video Player to watch/play Videos. It can also view Google Maps.

You can Download it for free on Mac or Windows from the following link: <https://www.redtigerscam.com/pages/gps-player>

You can choose different playback modes in Settings>video playback mode. And you can set playback speed, language, map and other functions.

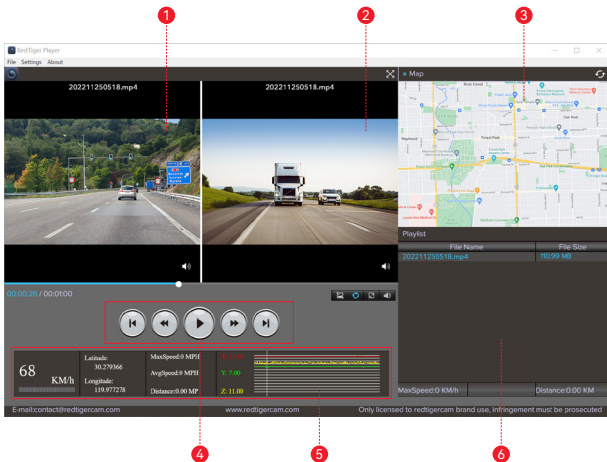

- ① Video play window (Front)
- ② Video play window (Rear)
- ③ Map and track display
- ④ Play control panel
- ⑤ Speed and driving state indication
- ⑥ Play list

### Note:

If the video files of front and rear road tracks are recorded synchronously and loaded into the playing list at the same time, they can be played separately in split left and right screens.

When you find the desired video file, hold down the left mouse button and drag the desired files to the video play window to play it.

## Installation

### **⚠ WARNING**

Please make sure to connect all cameras and wires before power on the cam screen, otherwise, the camera cannot work properly. Please follow the instructions below for the first-time installation of the redtiger dash cam.



Scan the QR code on the right to view the installation tutorial video.

### **• Insert Memory Card**

Insert the Memory Card into the dash cam, taking care that the gold contacts are facing towards the screen of the dash cam. Push the memory card until it clicks into the slot.

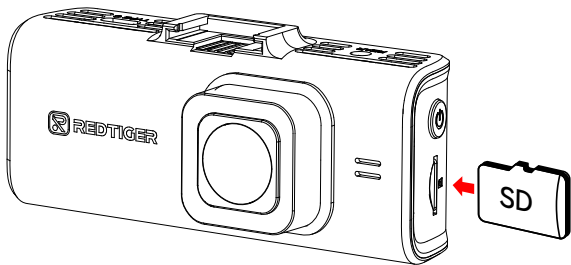

## • Mount The Front Camera

- 1 Please do a bench test before officially installing the dash cam to make sure all products are working properly.
- 2 Find the right spot on the front windshield. Wipe the pre-installed location with a clean cloth.
- 3 Use the suction cup to fix the F7N Touch dash cam on the windshield, adjust its angle to record a video with a better viewing angle.

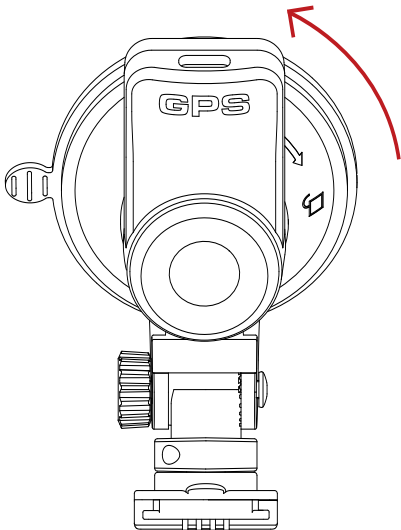

\*Adjust the GPS module counterclockwise to fix the bracket.

## \*Tips: Suction Cup Installation

We also have an adhesive of suction cup, which can prevent the suction cup from falling due to high temperature or long-term use. The following are its usage steps. It should be noted that the suction cup cannot be removed after the adhesive is applied.

- 1 Remove the transparent release film.

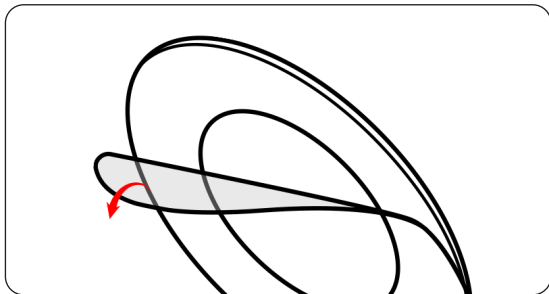

- 2 Stick the adhesive pad onto the suction cup base.

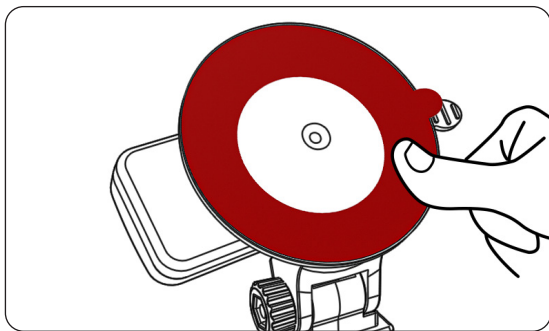

- 3 Attach the suction cup firmly to the electrostatic sticker on your windshield.

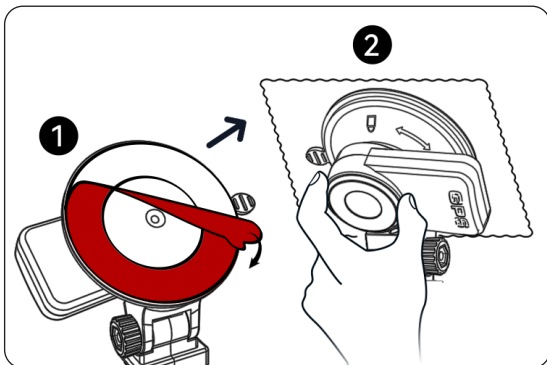

- 4 Press firmly to ensure a strong bond, and let it set for 24 hours for the best results.

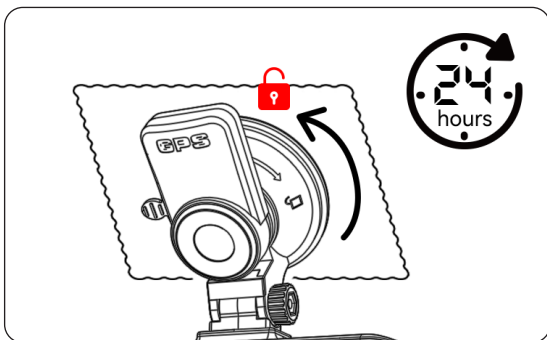

## • Mount The Rear Camera

- 1 Use a clean cloth to wipe the rear windshield where the rear camera needs to be installed.
- 2 Peel off the electrostatic sticker, transfer it to the place you want to stick it.
- 3 Drain the air bubbles on the electrostatic sticker.
- 4 Peel off the adhesive on the rear camera and stick it on the electrostatic sticker.

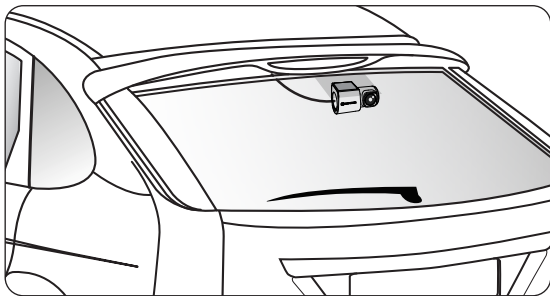

## • Wire Layout In The Vehicle

- 1 The car charger is connected to the cigar socket.
- 2 Connect the other end of the car charger to the dash cam.
- 3 Use the crowbar to run the power cable along the front windshield and the roof, and hide the cable down the A-pillar, so as not to block the driver's sight and cause danger.

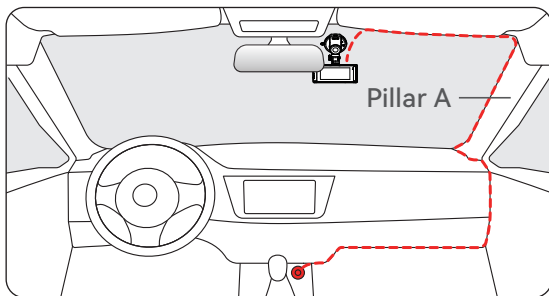

- 4 Connect the interface of the rear cable with the interface of the rear cam cable.
- 5 Hide the rear cam cable along the gaps between the front windshield and the ceiling, between the car body and the ceiling on the side of the passenger seat, and between the rear seats and the ceiling.

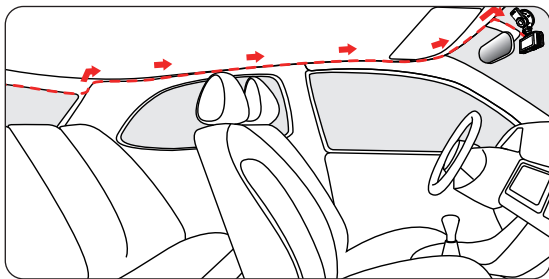

## Trouble Shooting

### • Why is there no GPS signal?

1. Clean and reconnect the probe on the main unit and bracket. Check for any interference in your car, like metal film on the windshield, radio antenna, or radar detector.
2. Move your car to an open area. Observe if the GPS icon on the screen turns green and displays GPS info.
3. Once GPS locks onto a signal, a satellite icon will appear at the bottom left of the screen. Green indicates positioning, while white indicates no positioning.

### • How to turn off the on/off music of dash cam?

Please go to Settings > Click Tone > Off.

When the click tone is turned off, the power on and off music will also be turned off.

### • Why does my dash cam prompt card error or please format Memory Card every once in a while?

Please follow the steps below to check:

1. Please go to Settings > Format Reminder to check whether the regular format reminder is enabled.
2. Format the Memory Card.
3. Restore factory settings and restart the dash cam.
4. Update the firmware.

### • Dash cam repeated restart/no boot?

1. Make sure you are using the original car charger.
2. Unplug the Memory Card, rear camera cable, and car charger in turn, and reinstall them. Check whether the short circuit is caused by accessories.
3. Reset the machine through the small hole at the bottom of the driving recorder.

4. If none of the above can solve the problem, please try to power on the USB cable to confirm whether the host can be used normally.
5. Please go to the official website to update the firmware.
6. If it is not resolved, please contact your dedicated customer service for a replacement.

• **Why "Mass storage" appears on the screen?**

"Mass storage" happens when you use a USB cable with data transfer mode causing the dash cam to enter transfer mode. In this mode, data can only be transferred; no other functions work. For best results, use the original car charger or a USB cable without data transfer mode.

• **Why can't I connect to Wi-Fi?**

1. Check the working distance of Wi-Fi, about 15ft.
2. Check the SSID and password of the Wi-Fi, or whether there are other devices connected to the Wi-Fi.
3. Turn off mobile data, security software, and VPN on your phone.
4. If the issue persists, please contact customer support for assistance.

• **Why is the time setting incorrect?**

The dash cam features built-in GPS. It automatically adjusts time based on your location and time zone, eliminating the need for manual time changes. And you can adjust the time through Settings > Time Zone/DST.

## Customer Service Center

If you have any problems with the function or installation, please feel free to reach us.



Help Center



WhatsApp



### For more information:

After sales: [help@redtigercam.com](mailto:help@redtigercam.com)

Business Cooperation: [contact@redtigercam.com](mailto:contact@redtigercam.com)

Customer Phone Service: +1 888 966 8028 (US)





# REDTIGER

CAM GOOD

Check us out here.  
Product and service are the foundation of Redtiger.

Instagram: @redtiger\_dashcam  
Facebook: Redtiger Dash Cam



[www.redtigercam.com](http://www.redtigercam.com)